

@olliwegner  
@stilkov



Please evaluate  
our talk via the  
mobile app!



INTERNATIONAL  
SOFTWARE DEVELOPMENT  
CONFERENCE

 Follow us @qconlondon



Oliver Wegner • Stefan Tilkov

# From Parts to a Whole: Modular Development of a Large-Scale e-Commerce Site

QCon, London 06/03/2014

innoQ

OTTO

# **1. Reviewing architectures**

# Generic Architecture Review Results

Building features takes too long

Technical debt is well-known and not addressed

Deployment is way too complicated and slow

Architectural quality has degraded

Scalability has reached its limit

“-ility” problems abound

Replacement would be way too expensive



Any architecture's quality is directly proportional to the number of bottlenecks limiting its evolution, development, and operations

# Conway's Law

## Organization → Architecture

“Organizations which design systems are constrained to produce systems which are copies of the communication structures of these organizations.” – M.E. Conway

# Reversal 1

## Architecture → Organization

Any particular architecture approach constraints organizational options – i.e. makes some organizational models simple and others hard to implement.

## Reversal 2

### Architecture → Organization

Choosing a particular architecture can be a means of optimizing for a desired organizational structure.



## **2. Rebuilding Otto.de**

**For the last 15 years the E-Commerce business has become more important**

Percentage of turnover

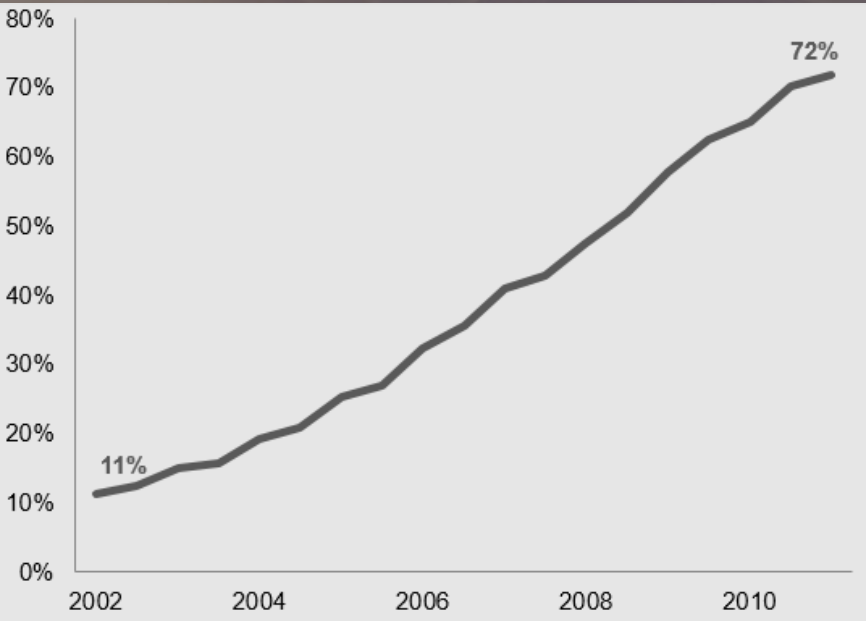

**4.200 Employees**    **> 2.1 Billion € turnover**

**> 2 Million items on Otto.de**

**80% turnover online**

Kleid.  
Gefunden auf **OTTO**.de



But why rebuild Otto.de?

# Goals

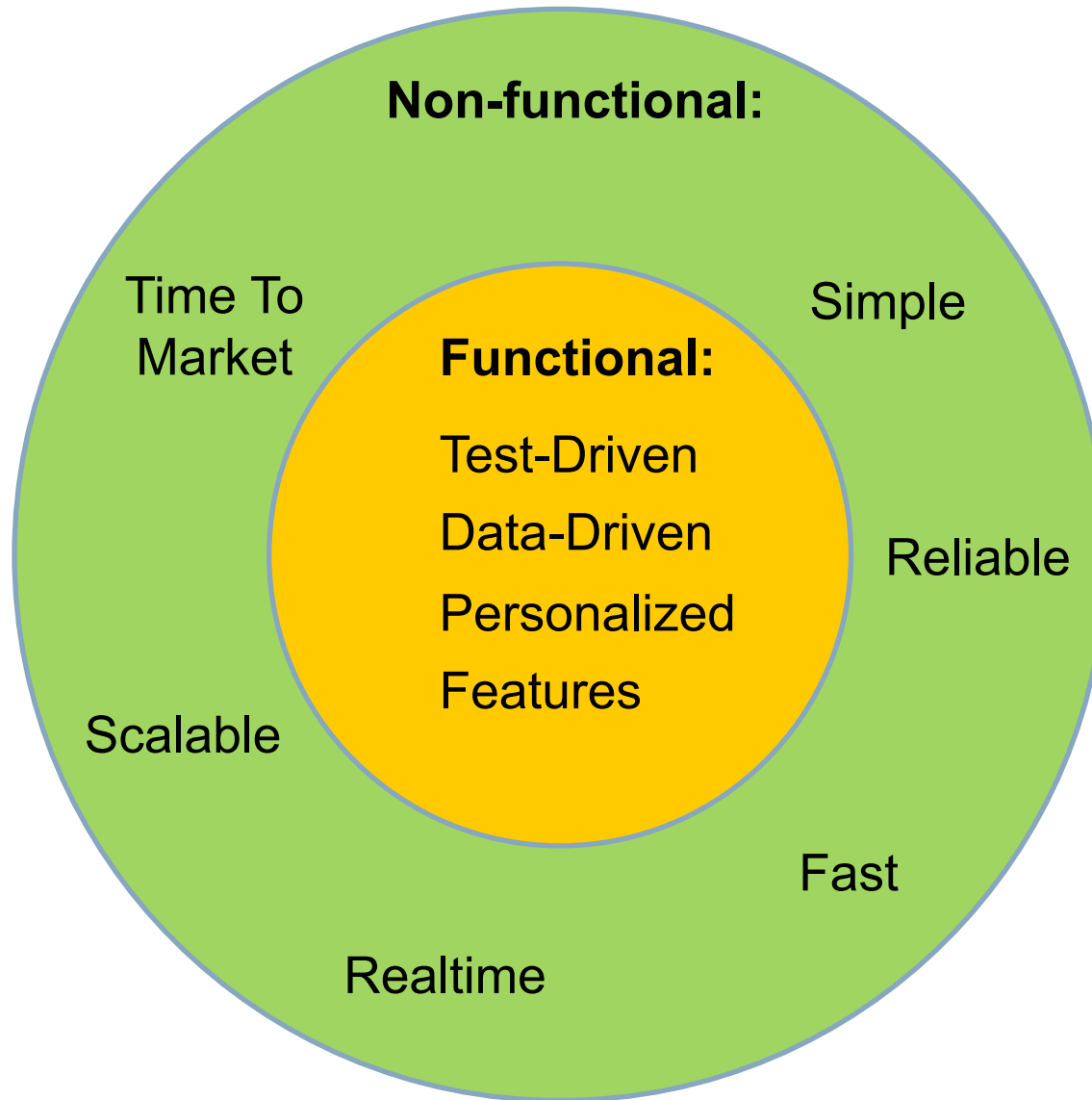

# How green is the green field?

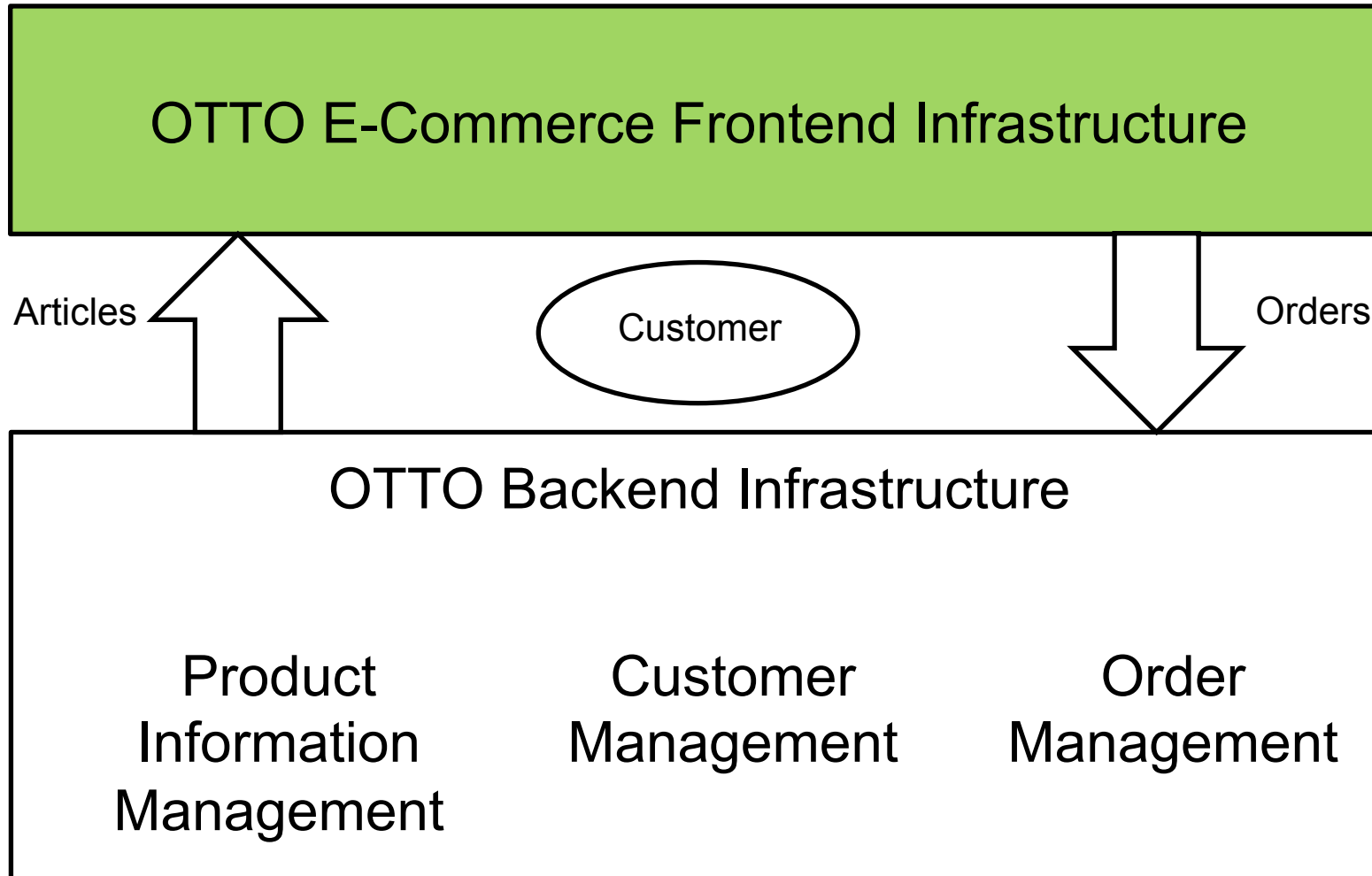

# Start of the project LHOTSE

Open Source as core technologies

One Prototype to define the technology stack

Project organization with autonomous teams

Scrum as an agile development method

Technical system architecture

### **3. A system-of-systems approach**

**Domain architecture**

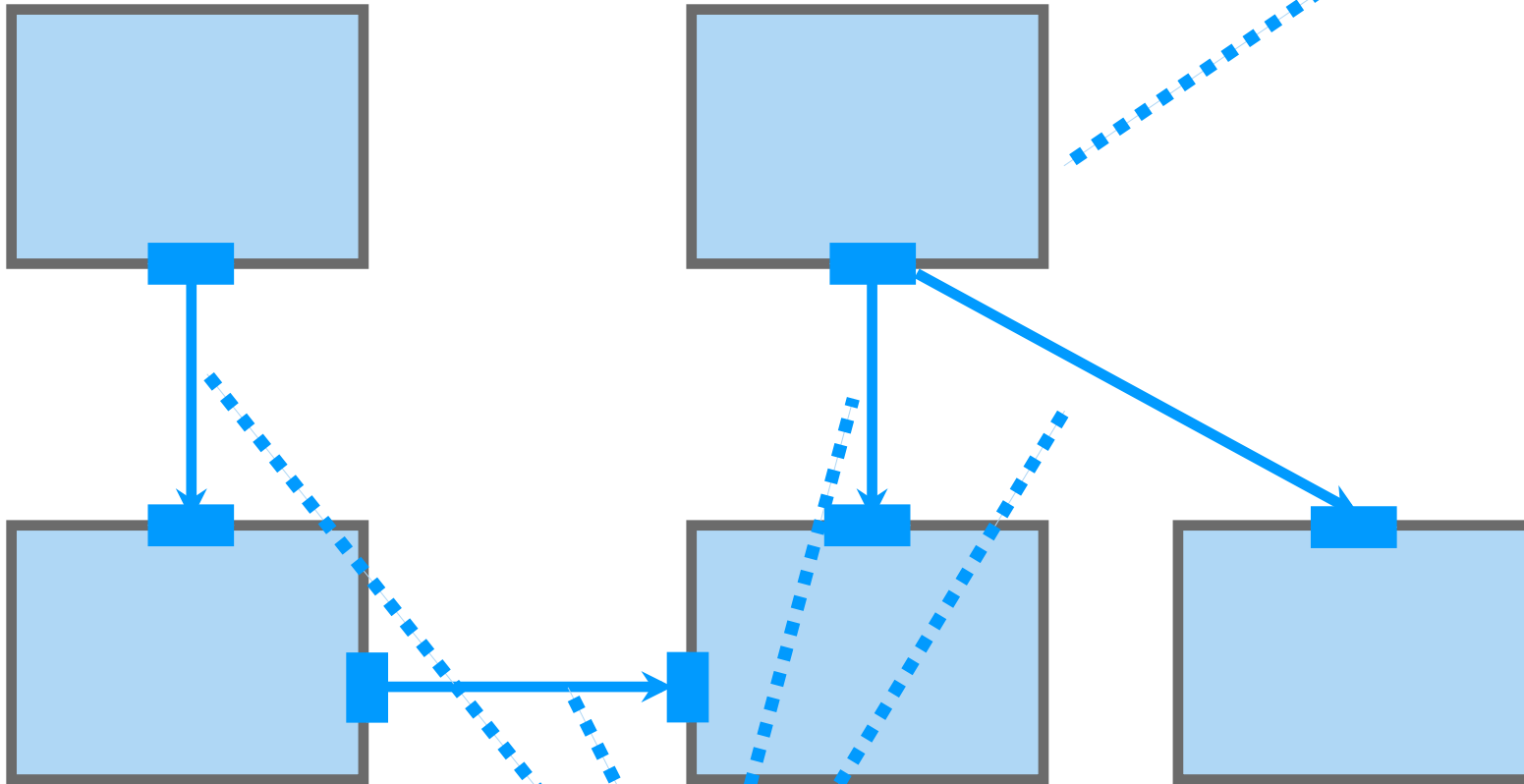

**Macro (technical) architecture**



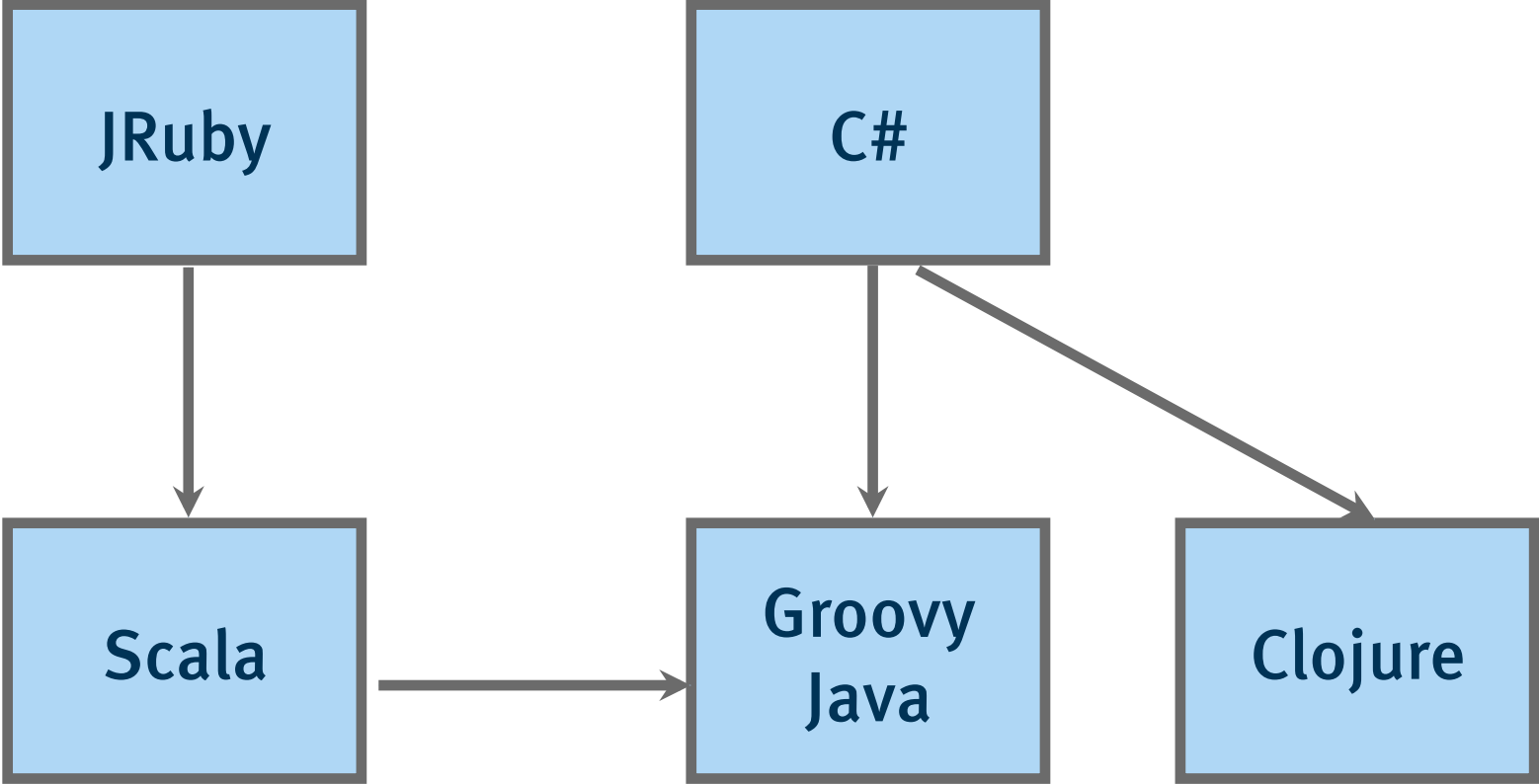

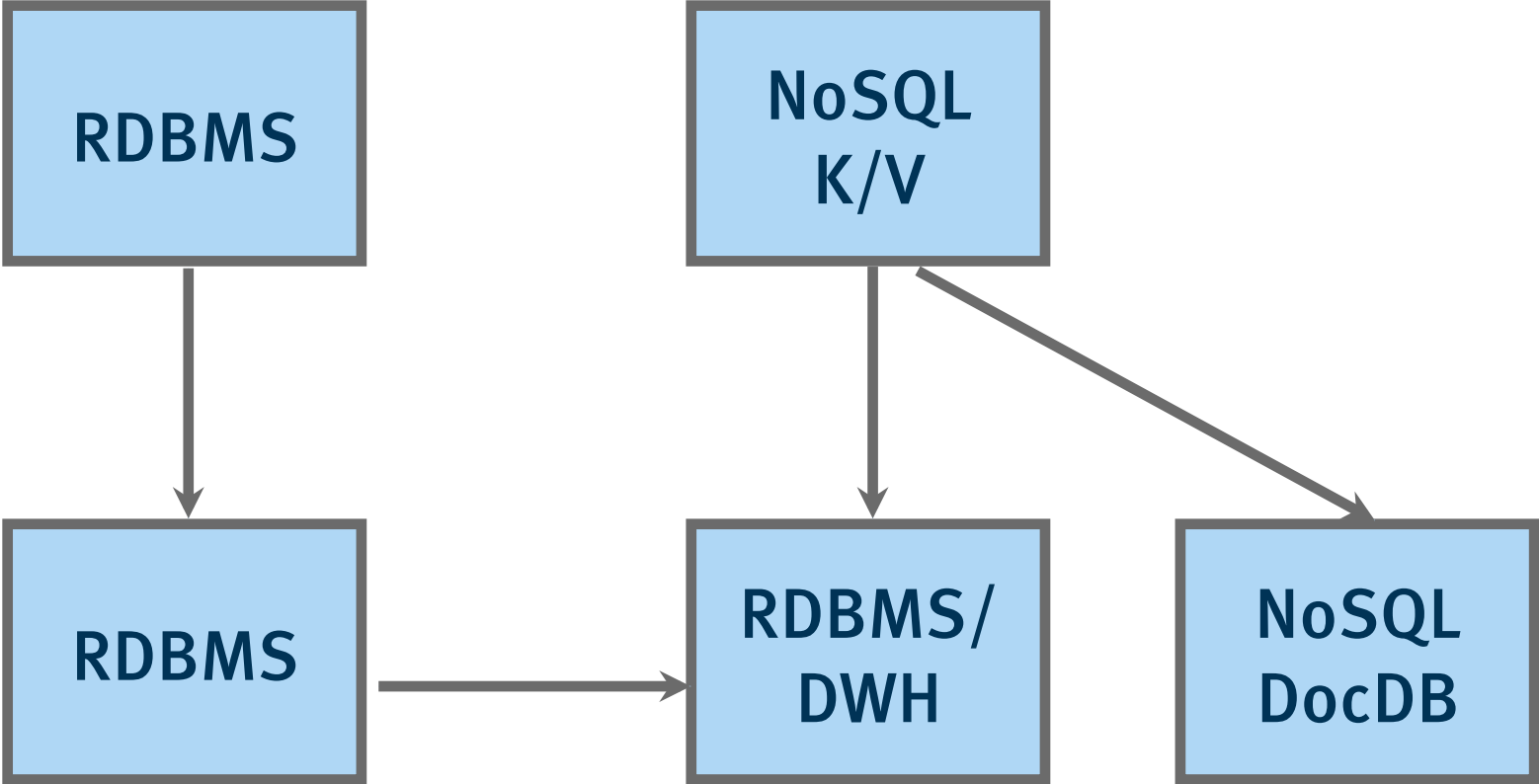

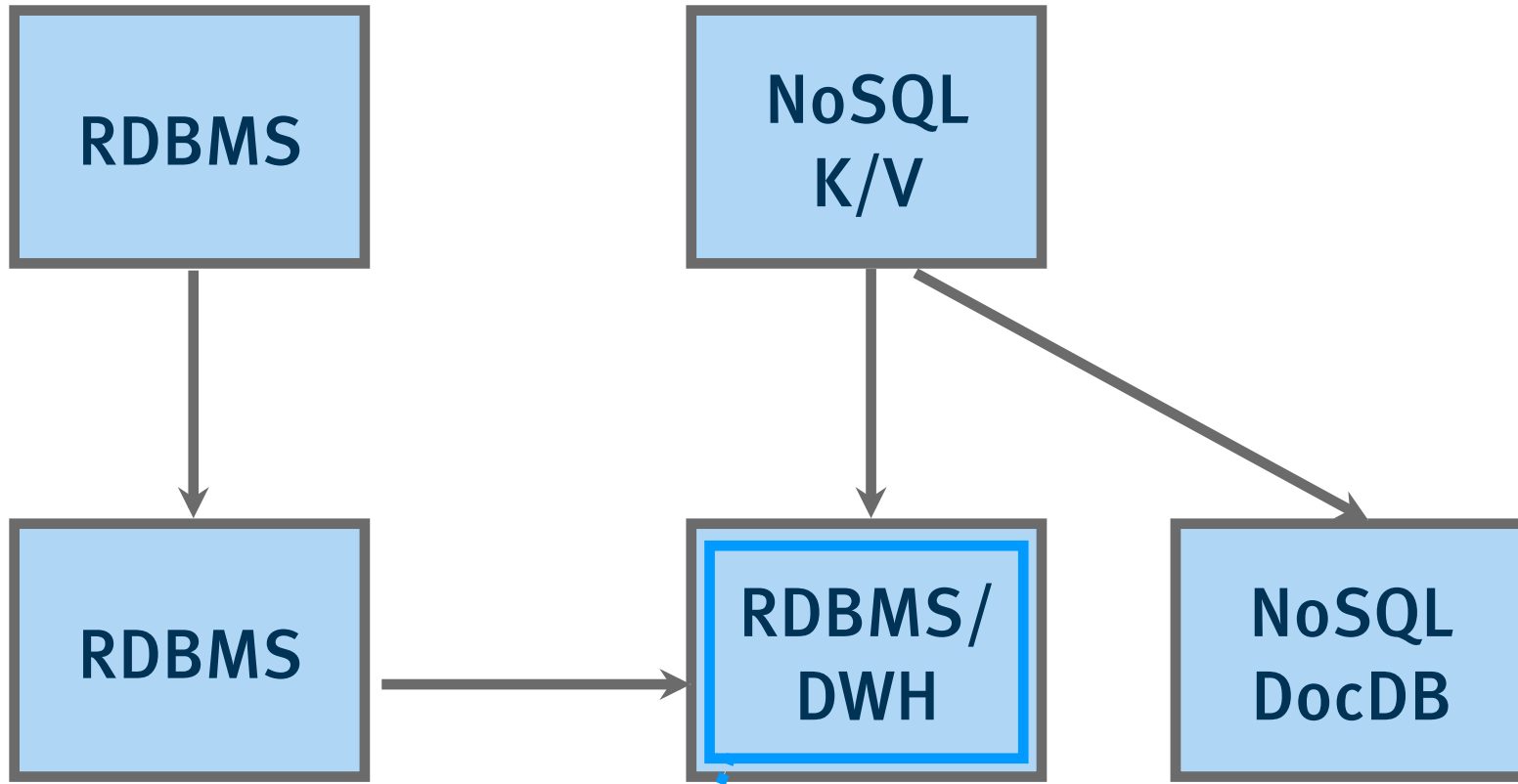

**Micro architecture**

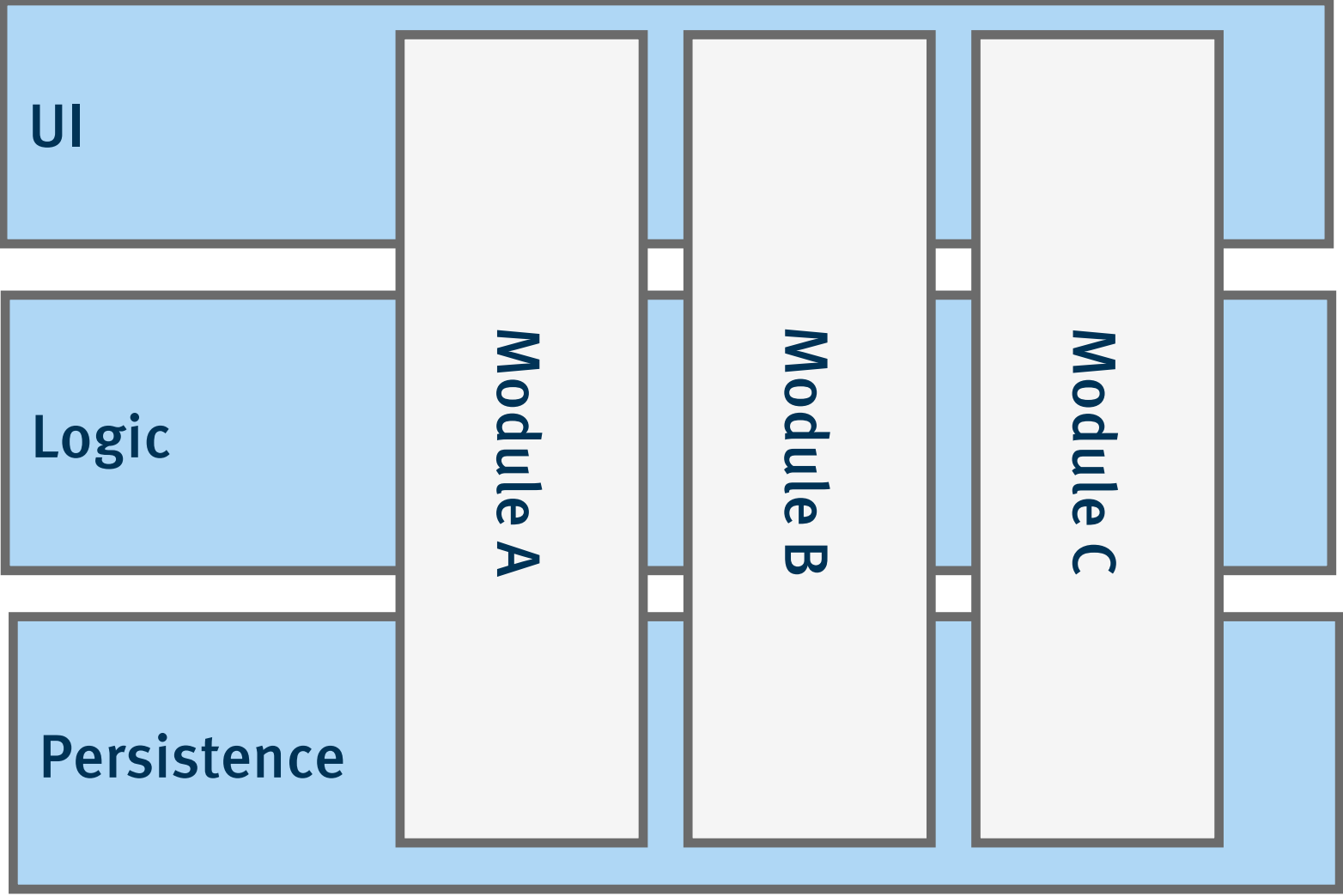

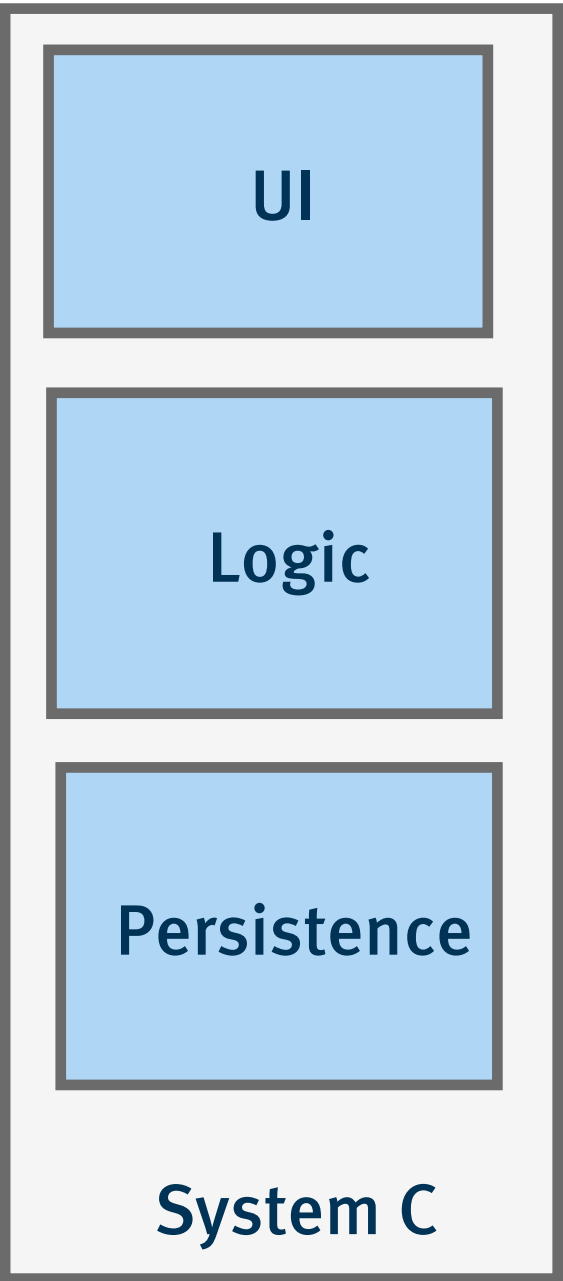
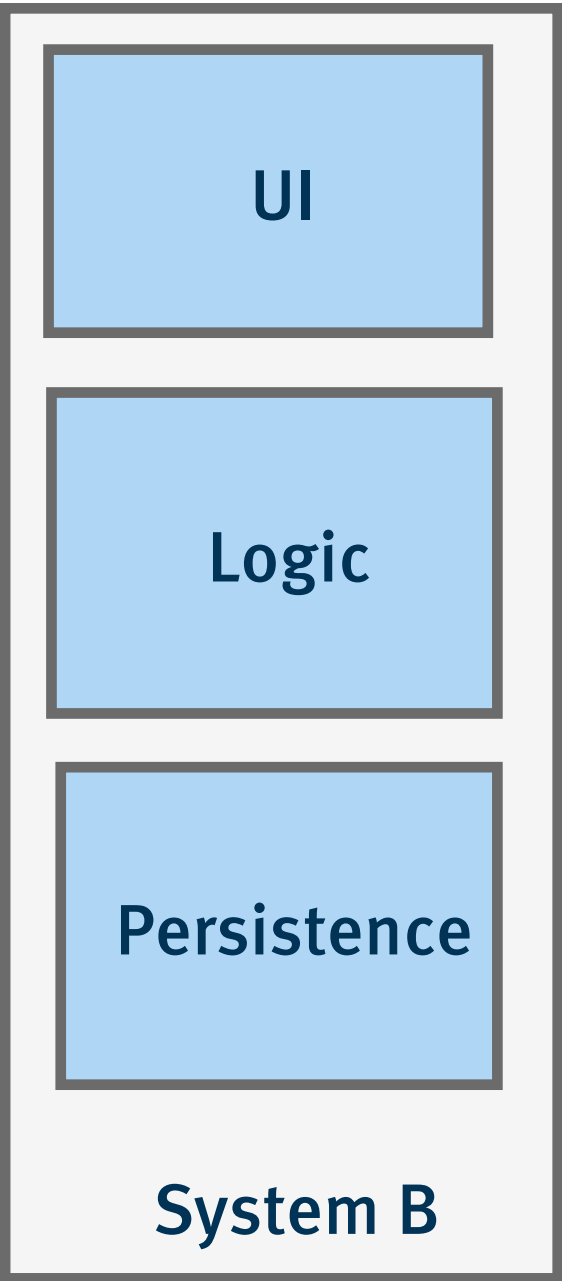
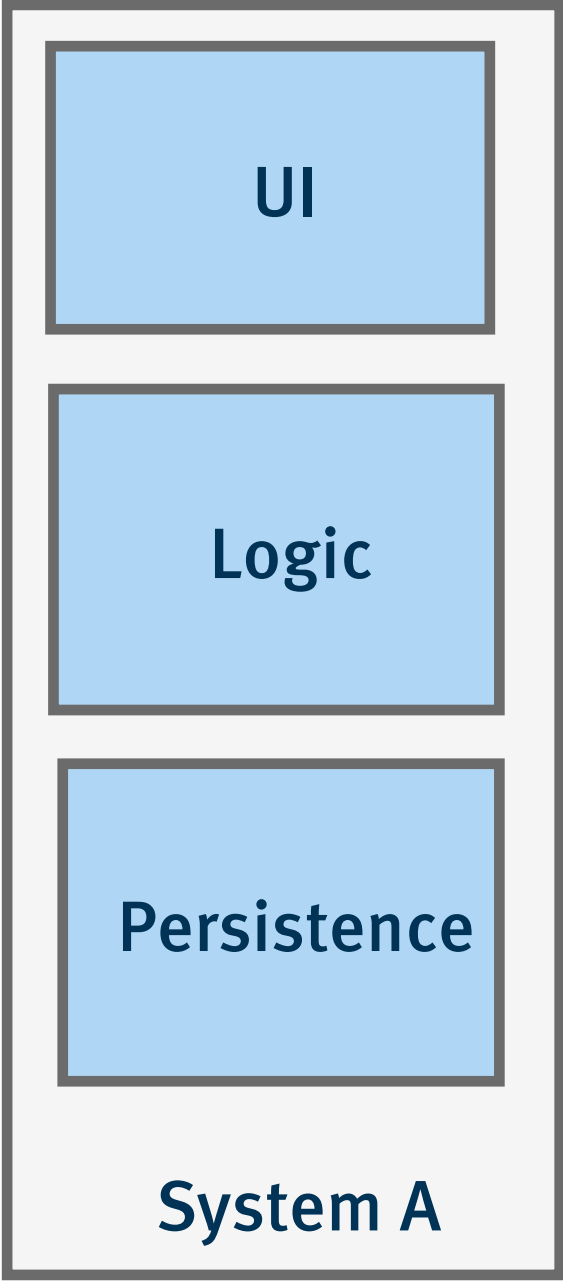

## **4. The Otto architecture**

# Buying Process – as you already know it

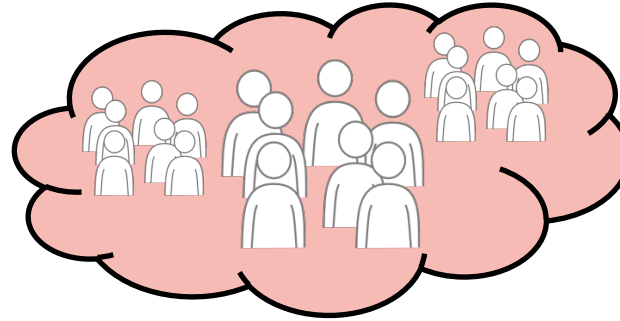

Customer Journey

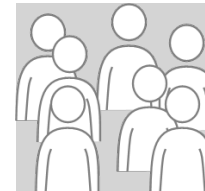
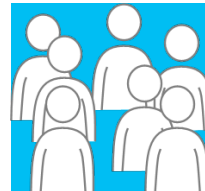

# The E-Commerce Business Architecture – Vertical and Horizontal aspects of the product Otto.de

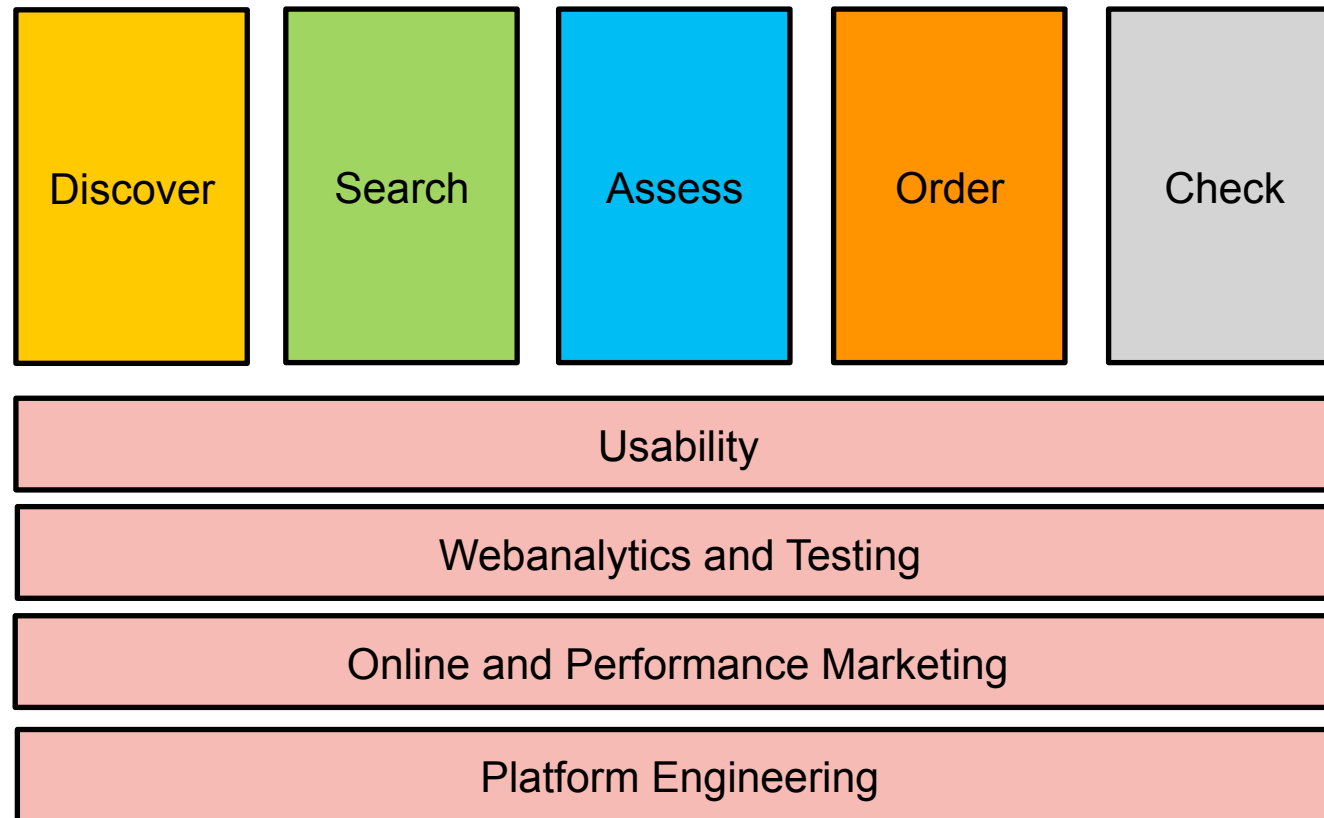

1 Website = 1 Product = 1 System = 1 Engineering Team ?



# System architecture is vertical

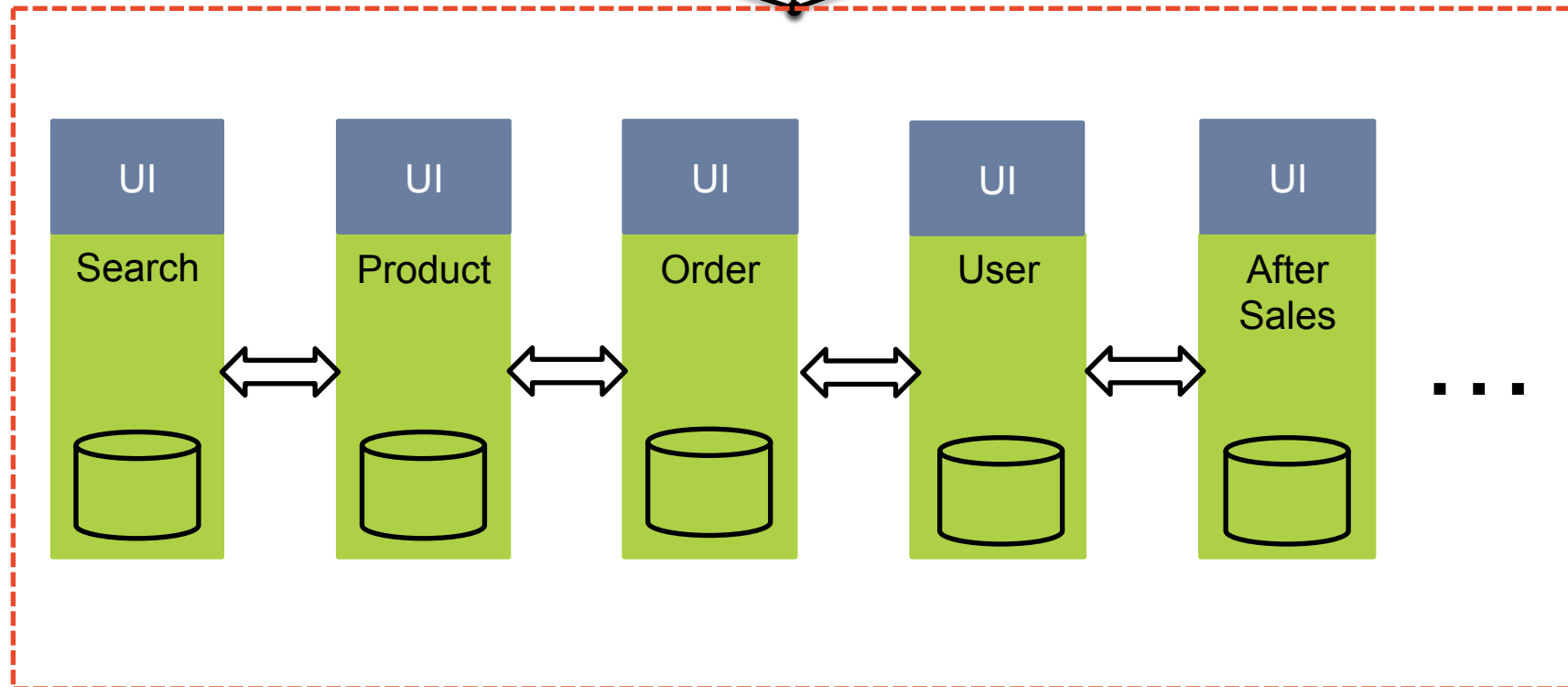
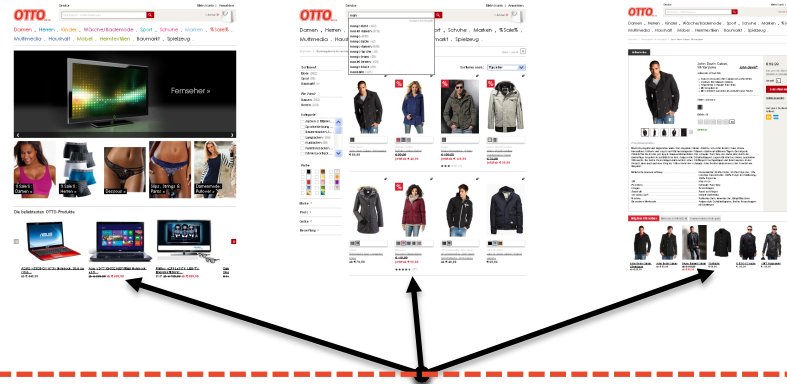

# Organizational aspects

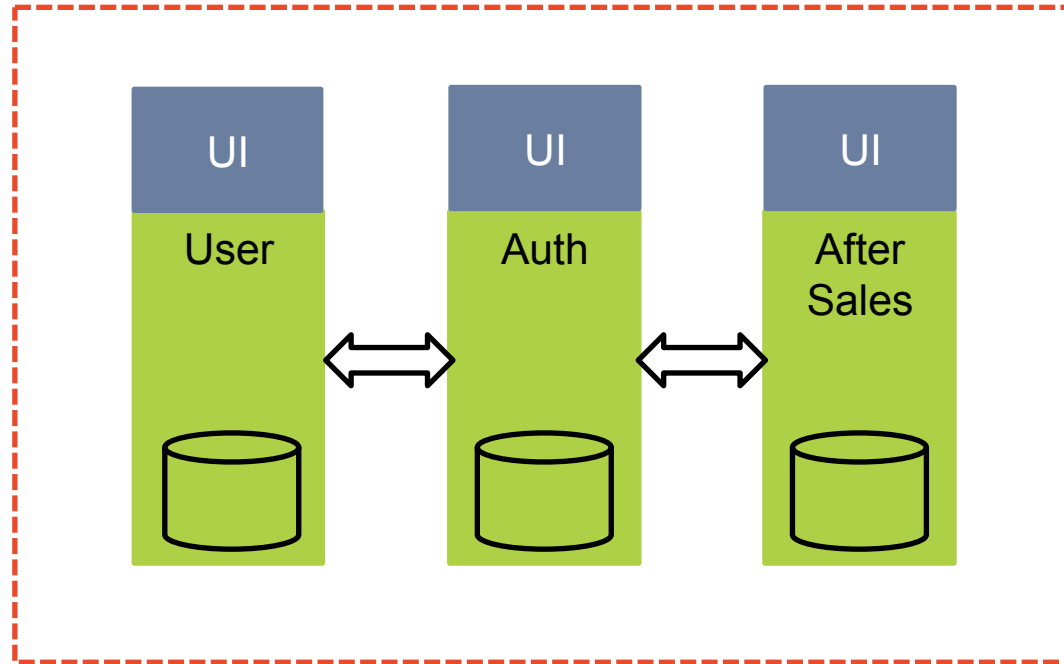
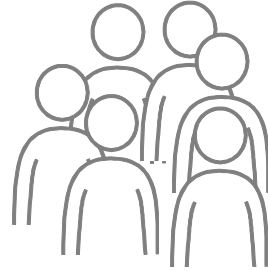

1 Team → N Systems

1 System → 1 Team

# Architecture rules

## Macro-Architecture

RESTful Architecture

Shared Nothing

Vertical Design

Data Governance

## Micro-Architecture

Buy when non core

Common Technologies

# The 3 Faces of Product Ownership

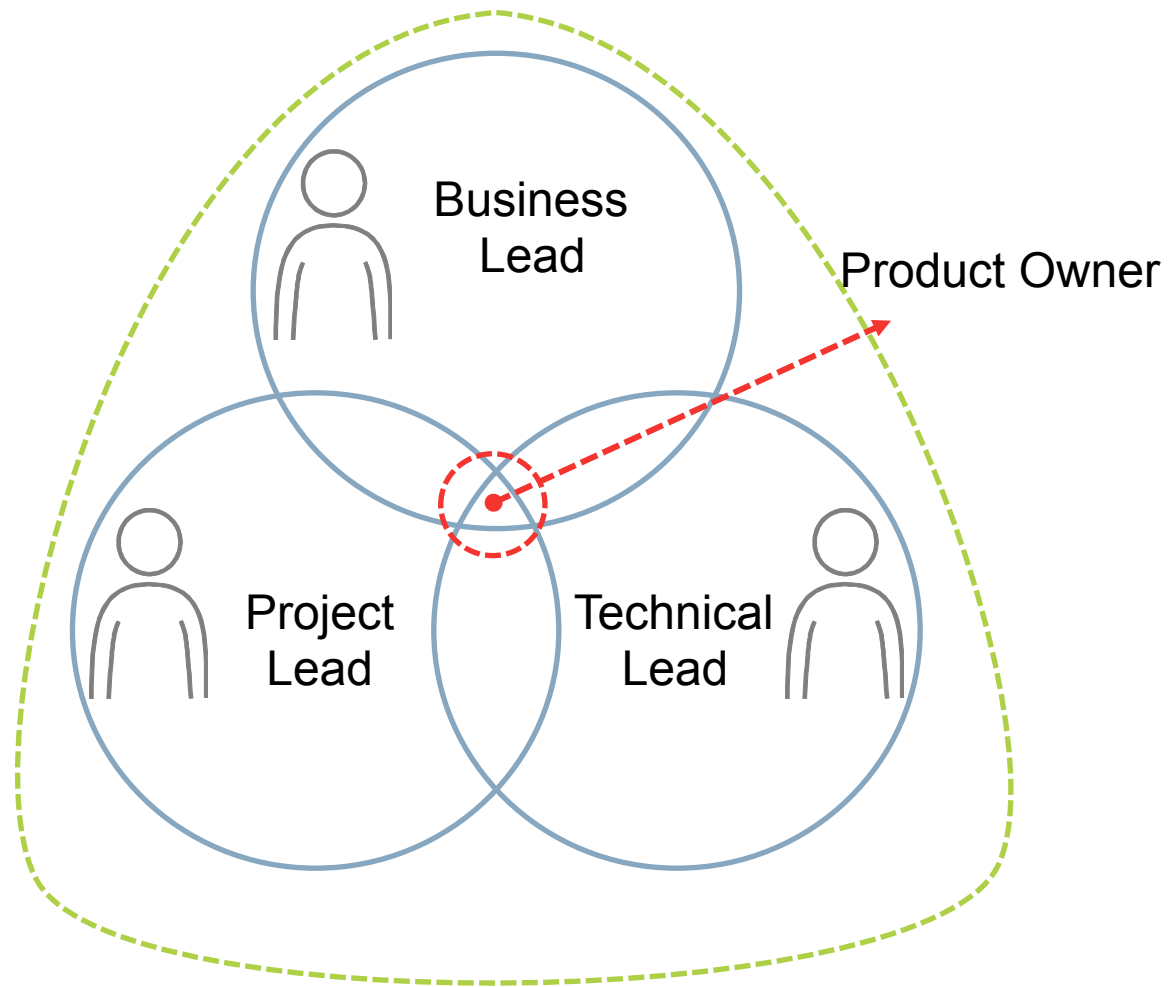

# Project start with distributed teams

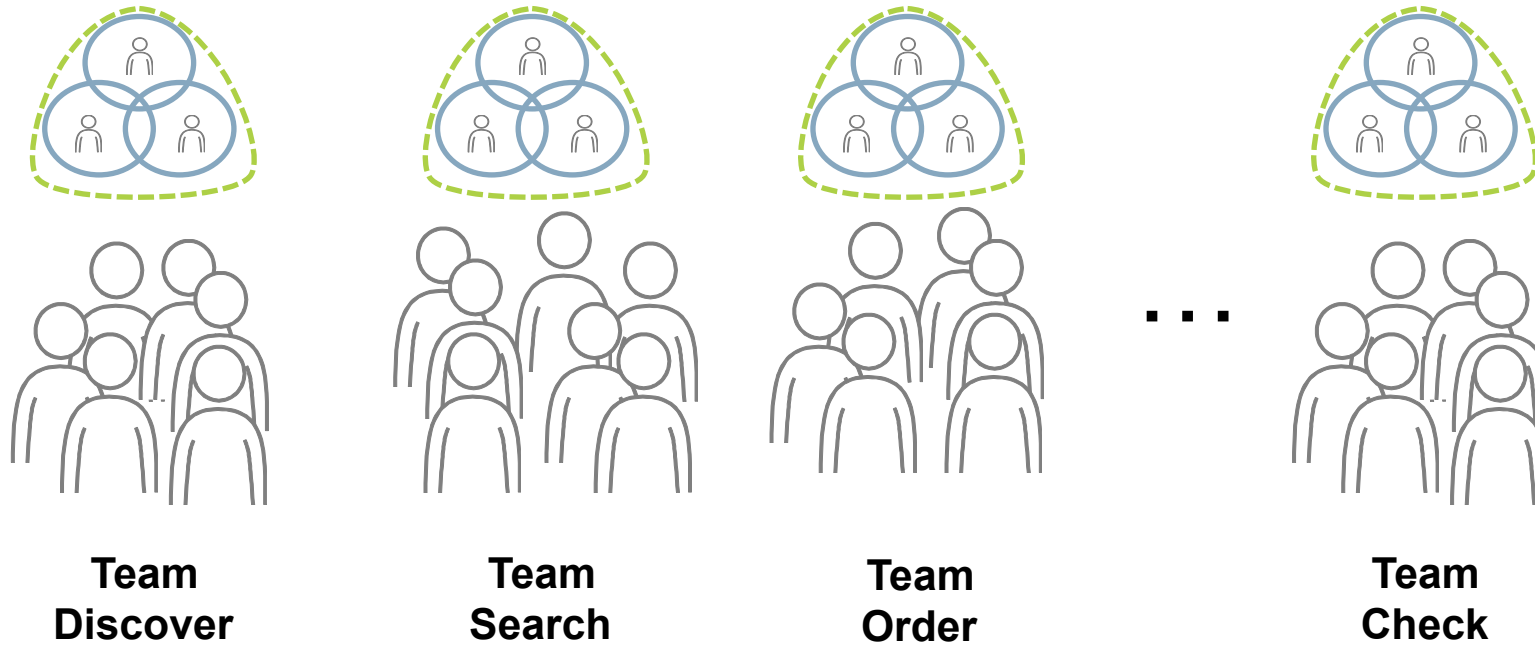

But how to deal with frontend integration?

# **5. Frontend Integration**

# Server-side integration options

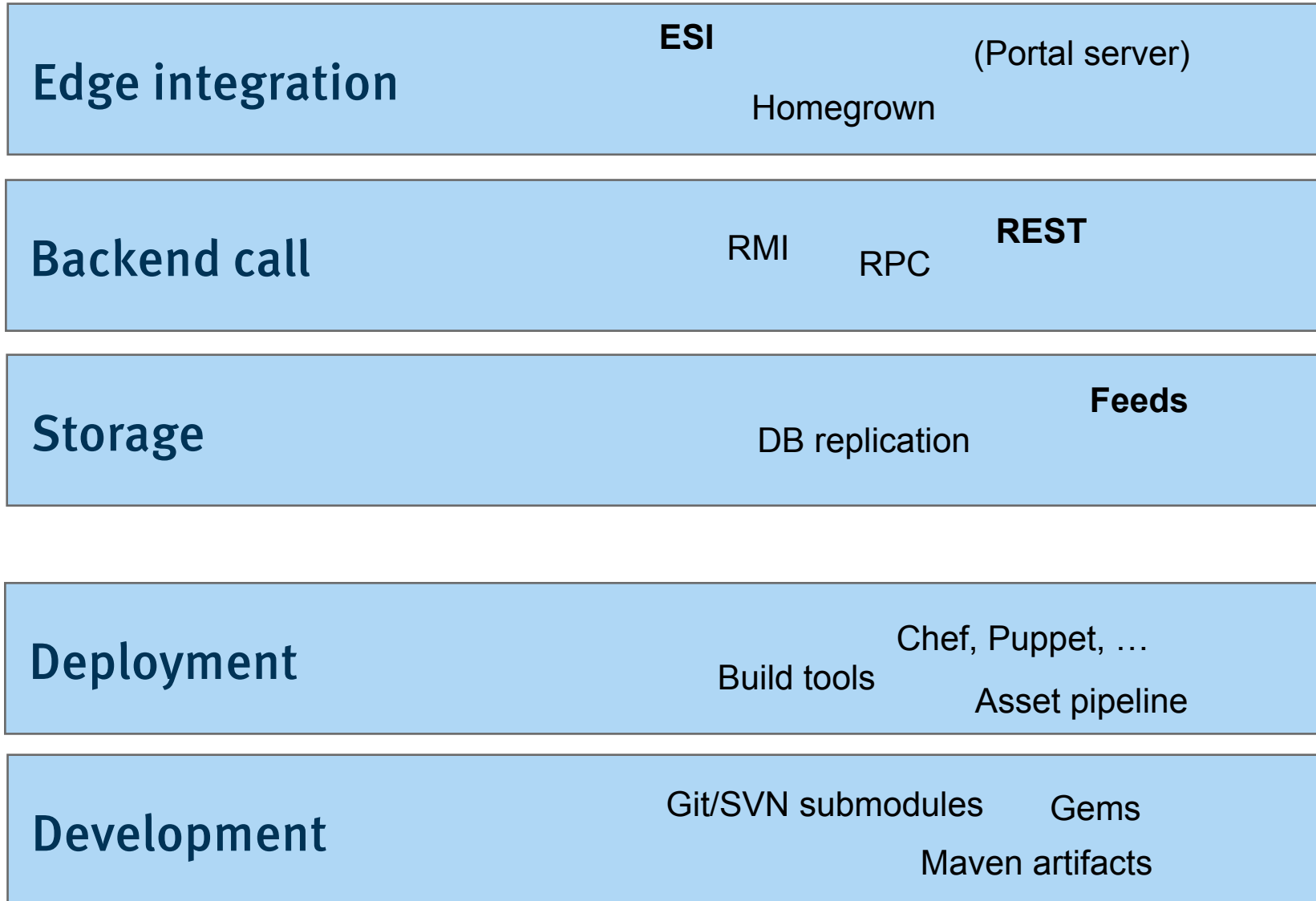

# Client-side integration options

**Client call**

SPA-style

**Replaced link**

Unobtrusive JS

oEmbed

ROCA-style

**Link**

Magical integration concept



# Otto.de – detail view

Service | Sitemap | **Oliver Wegner** (Sie sind nicht Oliver Wegner?) | Mein Konto | Mein Merkzettel (55) | Anmel

**OTTO**   1 Artikel

OTTO-Welten · Damen · Herren · Kinder · Wäsche/Bademode · Sport · Schuhe · Große Größen  
Multimedia · Haushalt · Möbel · Heimtextilien · Baumarkt · Spielzeug · Beauty · Marken · %Sale%

← zurück | Startseite > Suchergebnis für staubsauger  
> Siemens Bodenstaubsauger synchropower bag&bagless VS06G2545, beutellos, 2500 Watt

Artikel | Details | Kundenbewertungen (52)



**%**

Siemens  
Bodenstaubsauger  
synchropower  
bag&bagless VS06G2545,  
beutellos, 2500 Watt

**SIEMENS**

★★★★★ (52)

- Starker 2500 Watt Motor für besonders gründliche Reinigung
- DualFiltration: Saugt mit Staubcontainer oder Staubbeutel
- Praktisches Set mit Tierhaardüse und Hartbodendüse
- 10m Aktionsradius reduziert Steckdosenwechsel
- Ultra HEPA Hygienefilter. Für Allergiker geeignet [mehr Details...](#)

Farbe: **dunkel lila transparent**



**lieferbar in 2-3 Werktagen**

**24** Lieferung am Freitag: Bestellen Sie innerhalb 11 Std. und 24 Min. mit [24-Stunden-Lieferung](#)

UVP ~~€499,99~~  
(Sie sparen € 100,00 bzw. 50%)  
**jetzt € 99,99**

oder z.B. 12 Raten à € 9,00

inkl. gesetzl. MwSt, zzgl.  
[Service- & Versandkosten](#)

Anzahl

**In den Warenkorb**

[Artikel merken](#)

> Zahlpause ohne Aufpreis  
> Sicherer Kauf auf Rechnung  
> Bequeme Ratenzahlung  
> PaketShop-Lieferung möglich

[Artikel bewerten](#)

# Otto.de - Basket



Service | Sitemap **Oliver Wegner** (Sie sind nicht Oliver Wegner?) | Mein Konto | Mein Merkzettel (55) | Anmel

Suchbegriff / Artikelnummer eingeben



1 Artikel >



OTTO-Welten . Damen . Herren . Kinder . Wäsche/Bademode . Sport . Schuhe . Große Größen  
Multimedia . Haushalt . Möbel . Heimtextilien . Baumarkt . Spielzeug . Beauty . Marken . %Sale%

1 Ihr Warenkorb 2 Anmelden 3 Prüfen & Absenden 4 Danke!

Zur Kasse >

> Online-Bestellschein

Artikel von OTTO	Anzahl	Gesamtpreis (€)	Löschen
 <p><b>Siemens Bodenstaubsauger synchropower bag&amp;bagless VS06G2545, beutellos, 2500 Watt</b> dunkel lila transluzent   <a href="#">ändern</a> (1 Stk. = € 99,99) <b>lieferbar in 2-3 Werktagen</b></p>	1 ▼	99,99	x
		<b>Zwischensumme</b>	99,99
		<u>Versandkosten</u>	5,95
		<b>Gesamtsumme</b>	<b>105,94</b>
alle Angaben in Euro, inkl. MwSt.			

< Weiter einkaufen

Zur Kasse >

# Management of JS and CSS from each team

Service **Peter Palme** (Sie sind nicht Peter Palme?): Mein Konto | Mein Merkzettel (0) | Anmelden

**OTTO** beta

Suchbegriff / Artikelnummer eingeben   0 Artikel

Damen . Herren . Kinder . Wäsche/Bademode . Sport . Schuhe . Multimedia .  
Haushalt . Möbel . Heimtextilien . Baumarkt . Spielzeug . Marken . %Sale%

**SALE, SALE, SALE**  
Machen Sie Platz in Ihrem Kleiderschrank:  
Die neuen Mode-Schnippchen sind da!  
[Jetzt sparen >](#)

Empfehlungen für Sie

Samsung Galaxy S4 Smartphone, Touchscreen...  
**€ 679,99**

Bauknecht Waschmaschine Super Eco 6413, A+++...  
Energieeffizienz: A+++  
UVP ~~€ 649,00~~  
**€ 399,00**

Bikini-Hose, Buffalo  
**ab € 24,99**

Umschlag-Bikini-Hose "Country", Venice Beach  
**ab € 24,99**

Triangel-Bikini, JETTE  
**ab € 54,00**

Asus F75VC-TY08BH Notebook, 17,3 Zoll (433...  
~~ab € 549,00~~ **ab € 440,00**

## System View

Order

0 Artikel

User

**Peter Palme** (Sie sind nicht Peter Palme?): Mein Konto | Mein Merkzettel (0) | Anmelden

Personalization

Empfehlungen für Sie

Samsung Galaxy S4 Smartphone, Touchscreen...  
**€ 679,99**

Bauknecht Waschmaschine Super Eco 6413, A+++...  
Energieeffizienz: A+++  
UVP ~~€ 649,00~~  
**€ 399,00**

Bikini-Hose, Buffalo  
**ab € 24,99**

Umschlag-Bikini-Hose "Country", Venice Beach  
**ab € 24,99**

Triangel-Bikini, JETTE  
**ab € 54,00**

Asus F75VC-TY08BH Notebook, 17,3 Zoll (433...  
~~ab € 549,00~~ **ab € 449,99**

# Separate teams for horizontal aspects

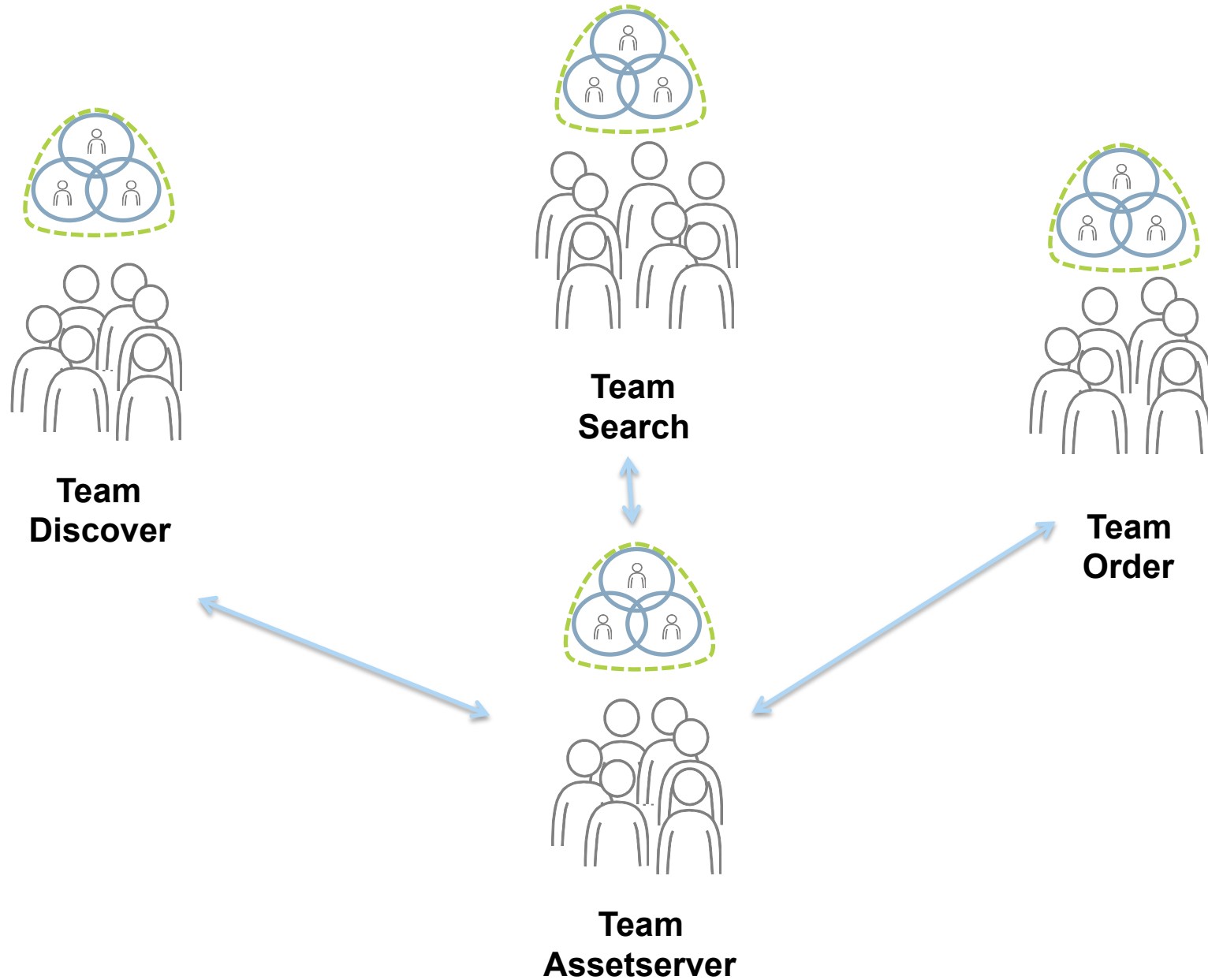

# DEPLOYMENT

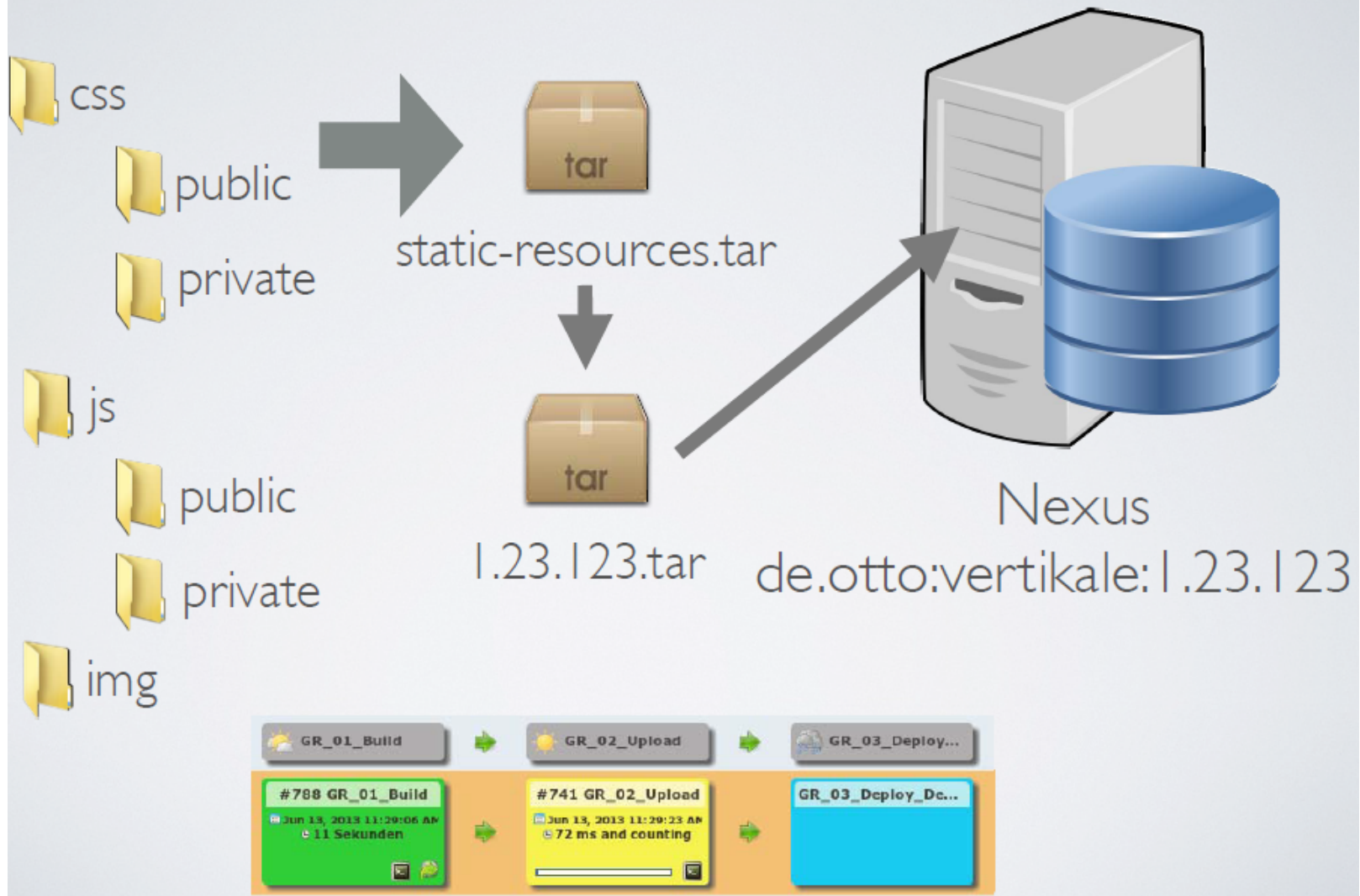

# Decoupling

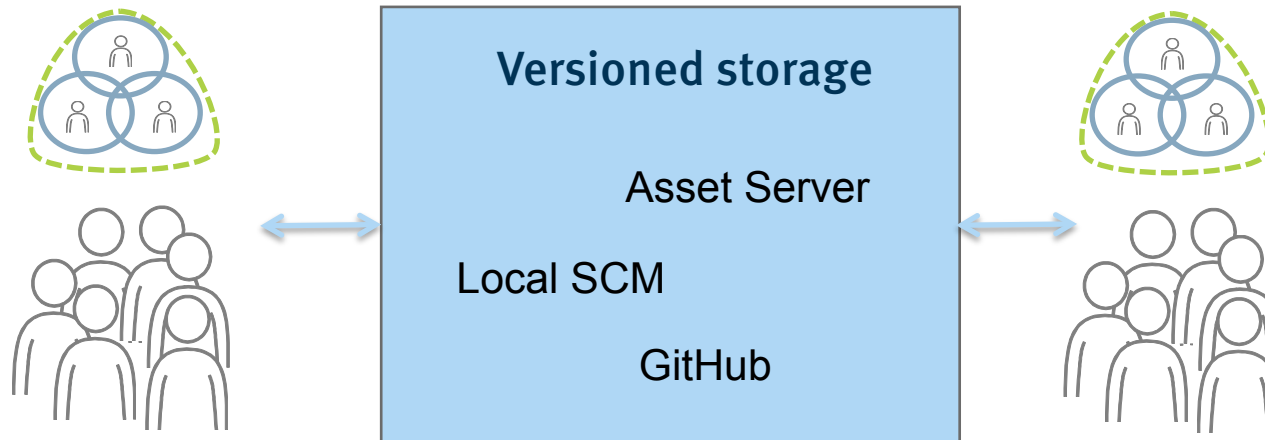

## **6. A/B-Testing**

# AB-Testing in a distributed environment – What is an AB-Test

Service | Sitemap | Oliver Wegner (Sie sind nicht Oliver Wegner?) | Mein Konto | Mein Merkzettel (00) | Anmelden

OTTO

Suchbegriff / Artikelnummer eingeben   1 Artikel

OTTO-Welten . Damen . Herren . Kinder . Wäsche/Bademode . Sport . Schuhe . Große Größen  
Multimedia . Haushalt . Möbel . Heimtextilien . Baumarkt . Spielzeug . Beauty . Marken . %Sale%

Startseite > Herrenmode > Marken > Jack & Jones (1.978)

**Jack & Jones**

Accessoires (88)  
Anzüge (41)  
Hemden (266)  
Hosen (70)  
Jacken (116)  
Jeans (167)  
Krawatten (9)  
Mantel (19)  
Polo Shirts (66)  
Pullover (142)  
Sakkos (46)  
Schuhe (104)  
Shirts (509)  
Shorts & Bermudas (87)  
Sonnenbrillen (6)  
Sportbekleidung (101)  
Strickjacken (43)  
Sweatshirts & -jacken (209)  
Taschen & Reisegepäck (8)  
Westen (22)

**100 Tage Zahlpause ohne Aufpreis - nur bis 03.03.2014**  
Gilt für das gesamte OTTO-Sortiment. [Alle Details hier](#) >

**JACK & JONES**  
Zu Pullover & Strick >

**OTTO entdecken**

Damenbademode: Beachtime >  
Damenbademode: Strandbekleidung >  
Damenmode: Shirts >  
Damenbademode: Bikinis >  
TV & Audio: Fernseher >

**OTTO entdecken**

Jeans >  
Jacken >  
Shorts & Bermudas >  
Sportbekleidung >

1%

99%



# Solution with a centralized framework every team has to include in their repository

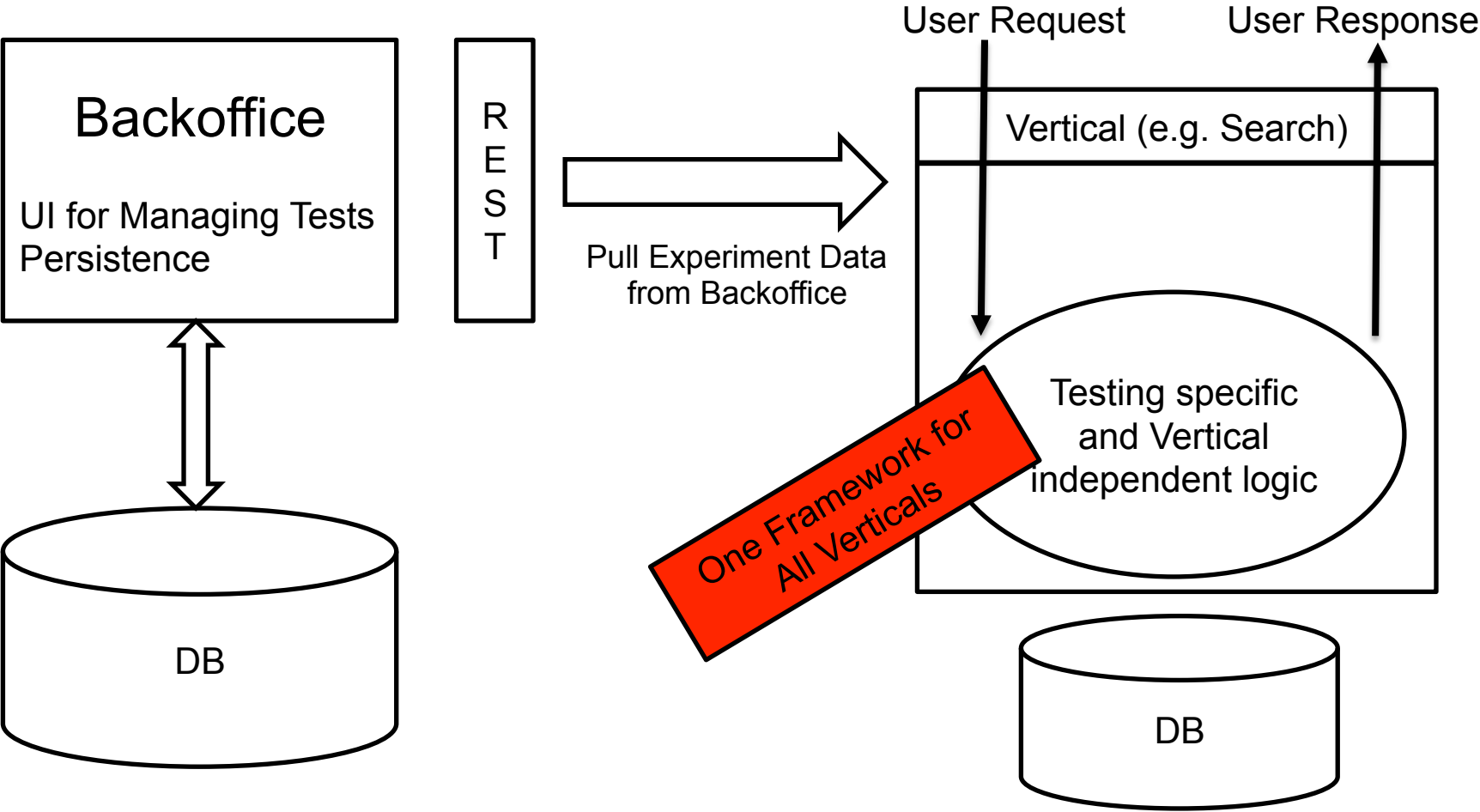

# Solution with a dedicated Vertical and loose coupling

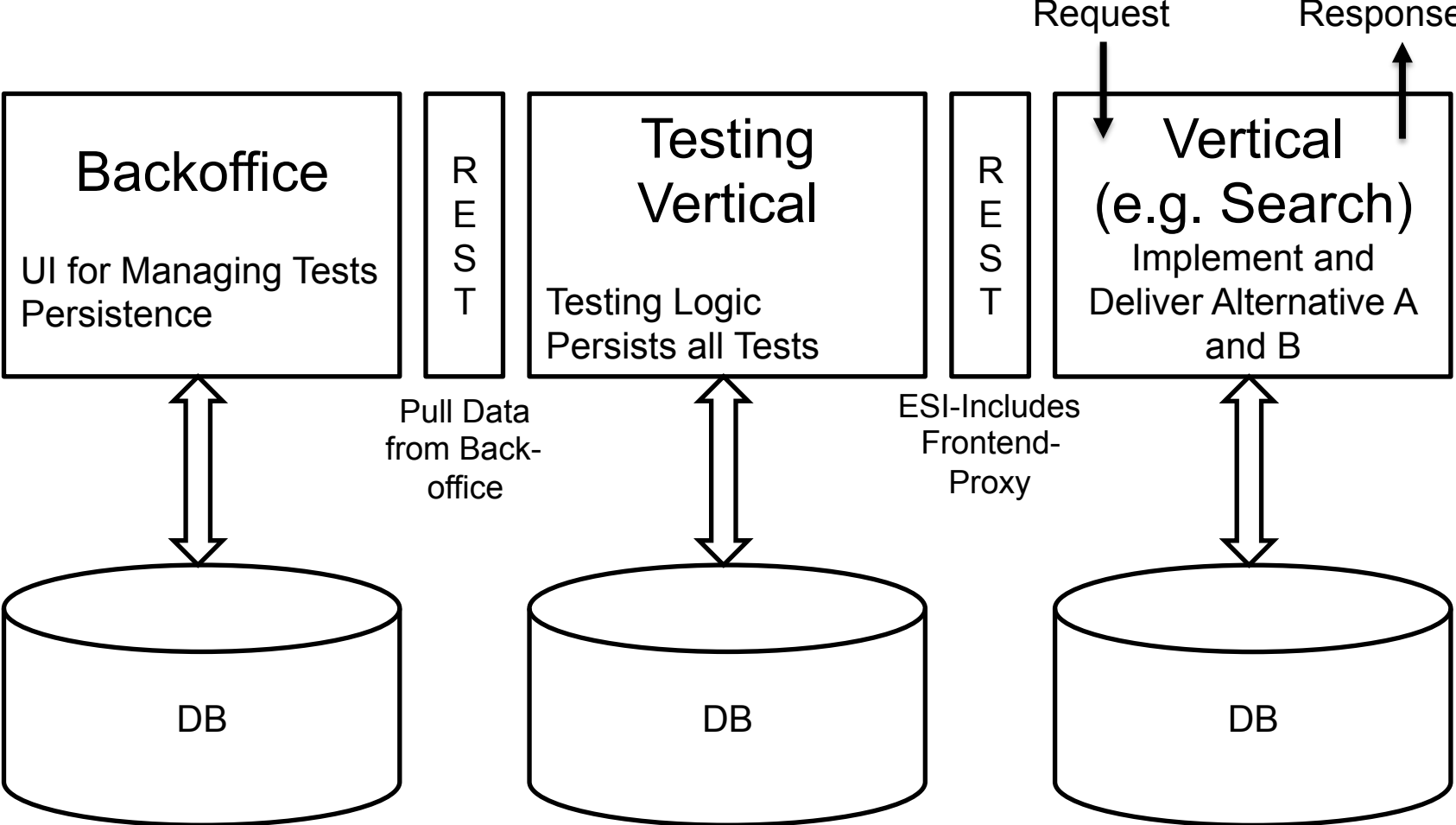

# **7. Conclusion**

# Results of the project LHOTSE

2 years in total

Scaled to >100 people

Finished in budget

Finished in quality

Finished before schedule: October, 24th → 4 months earlier

Minimum Viable Product

# Lessons learned in applying a system-of-systems approach

Independent,  
autonomous systems for  
maximum decoupling

Prefer “pull” to  
“push” sharing

Strict macro  
architecture rules

Minimize cross-  
functional concerns

Address cross-  
functional concerns

Minimize need  
for coordination

Be skeptical of  
“easy” solutions

Teams with  
their own  
decisions

@olliwegner  
@stilkov



Please evaluate  
our talk via the  
mobile app!



 Follow us @qconlondon

**BACKUP**

# Platform Engineering delivers the basic infrastructure for all verticals

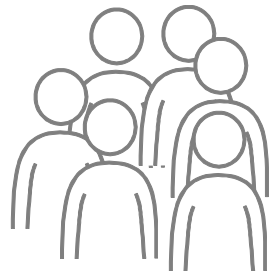
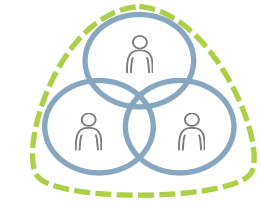

**Team Discover**

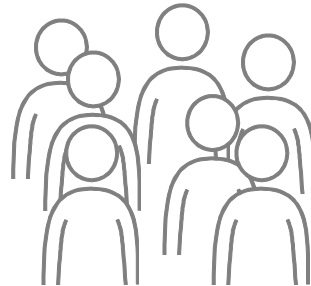

**Team Search**

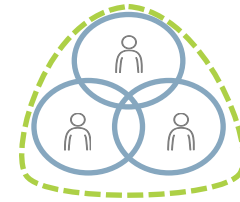

**Team Order**

...



**Team Platform Engineering**

Monitoring

Logging

Deployment

Provisioning

Network

Infrastructure Components



# Microservices?

## Microservices Approach

- Very small
- 100s
- Does one thing only
- Separate client (?)

## Vertical Systems Approach

- Medium-sized
- 10s
- Small # of related things
- Includes UI